

Luna M Black corner  
2869.550

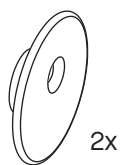

[deknudtmirrors.com](http://deknudtmirrors.com) | Products | Luna M Black corner | scroll to INSTRUCTION MANUAL

suspension accessories delivered with the mirror



2x



2x



2x

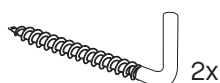

2x



2x

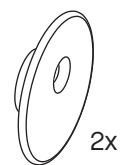

2x



2x



2x

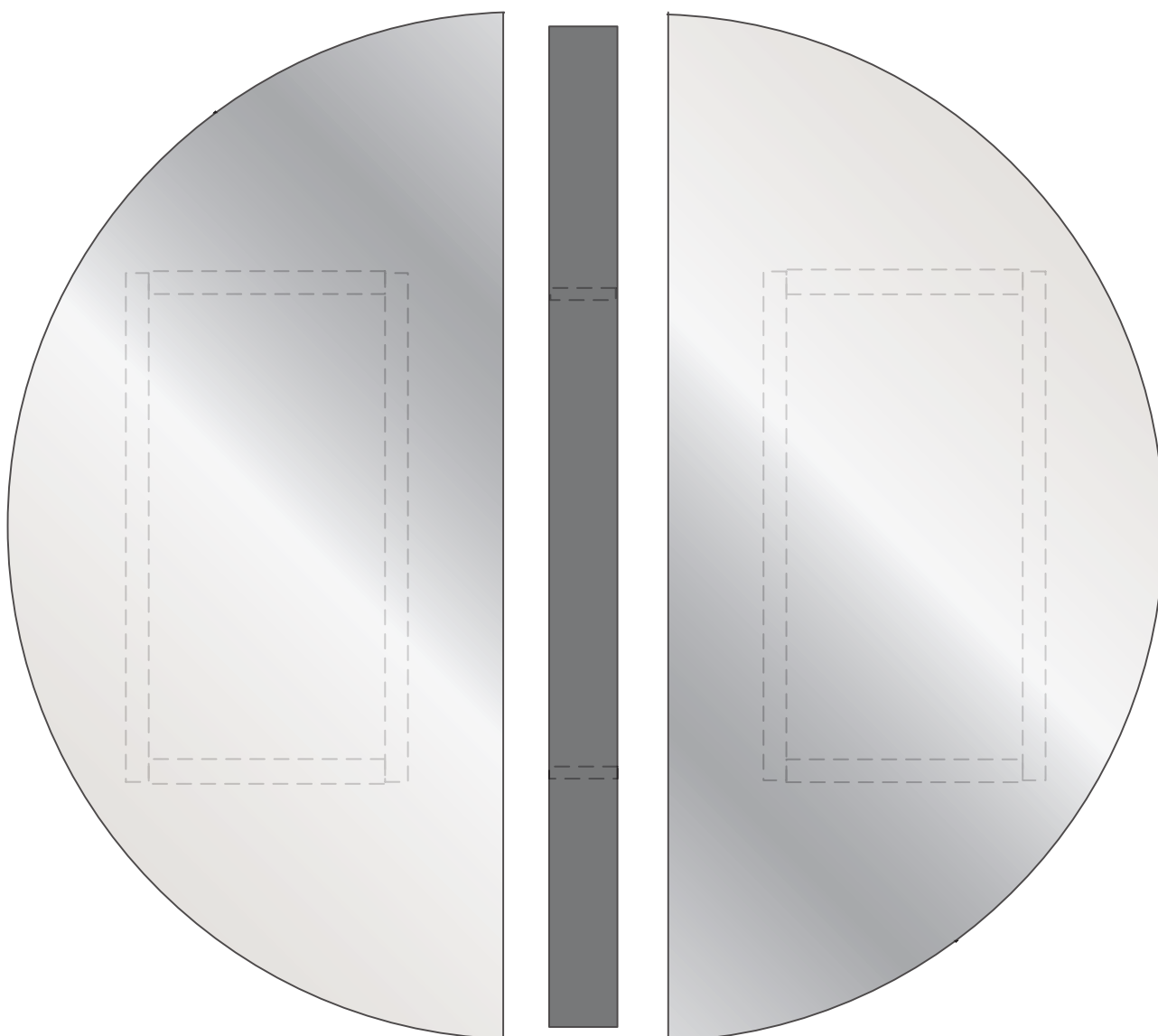

mark the suspension point on your wall  
drill holes and place the plugs, washers and screws or plugs and hooks

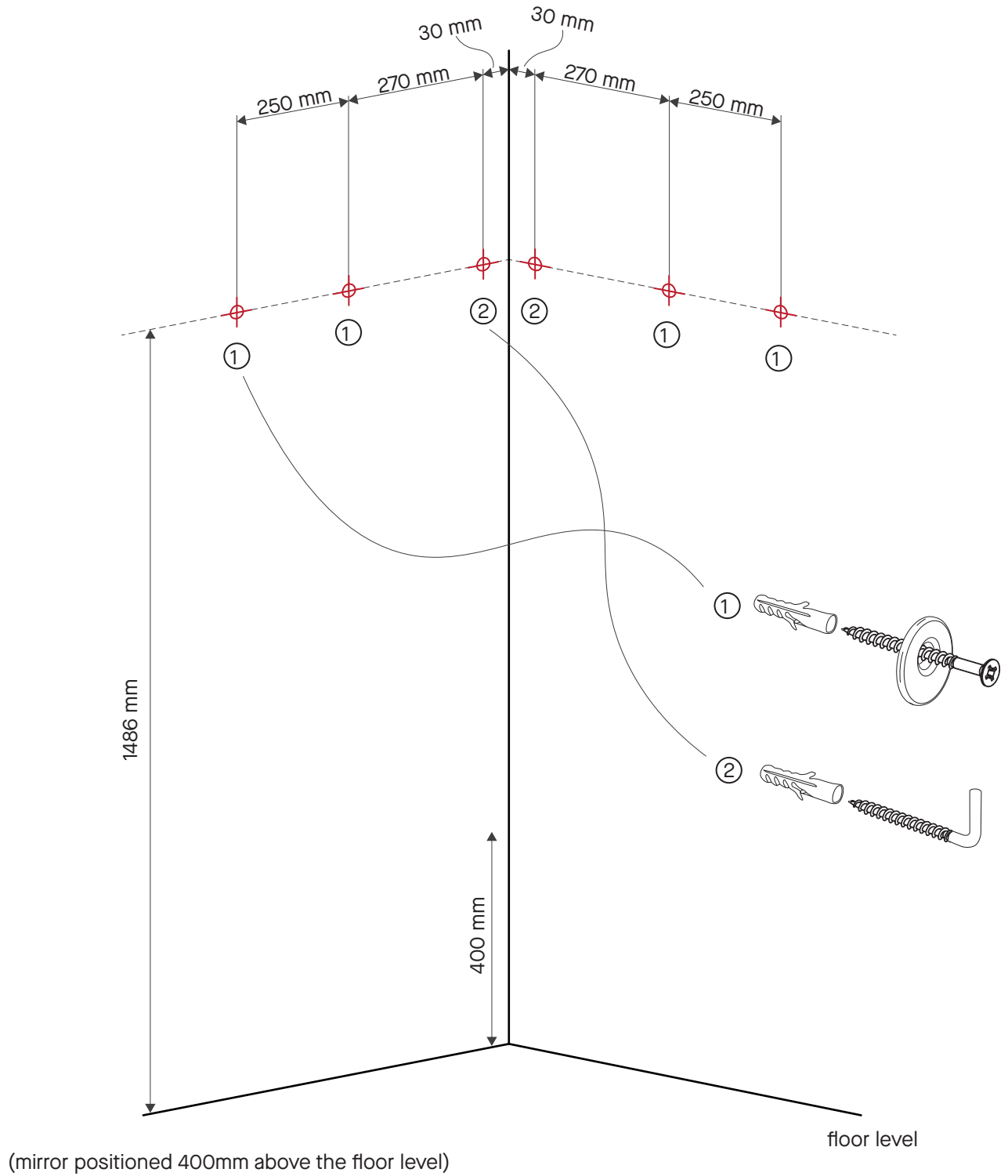

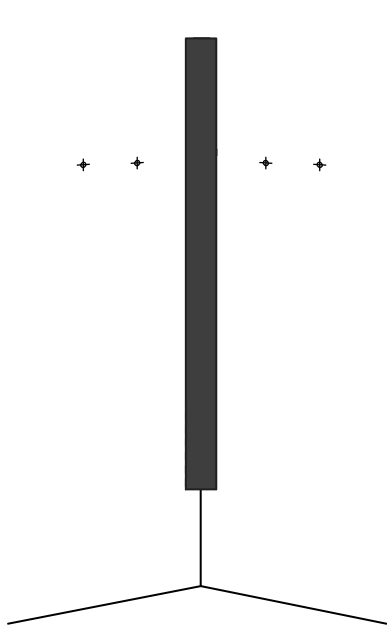

place the central element on the hooks making sure the hooks are inserted in the slots

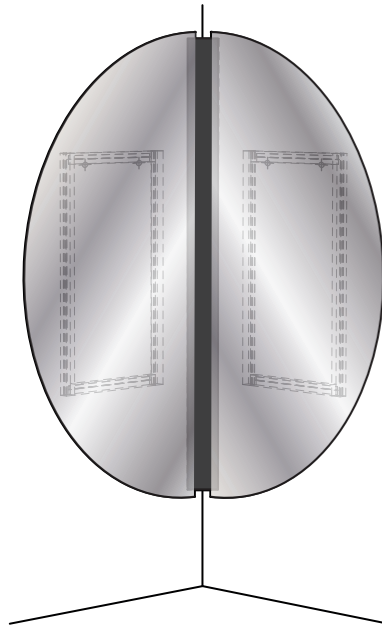

place the 2 mirrors on the washers

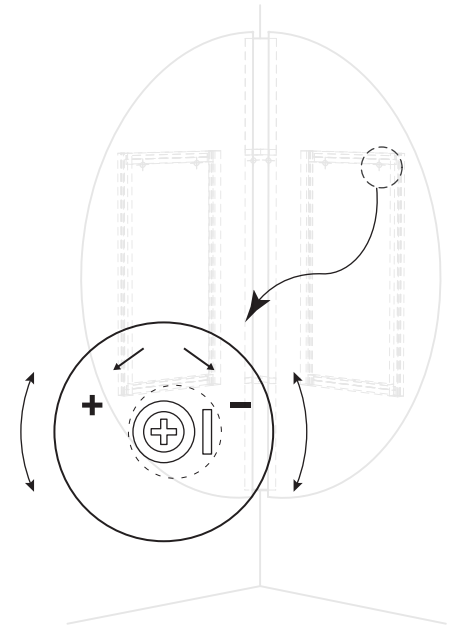

by turning the washers you can slightly adjust the level of the mirrors

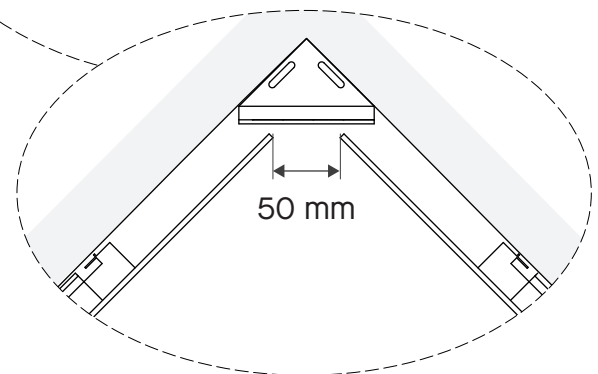
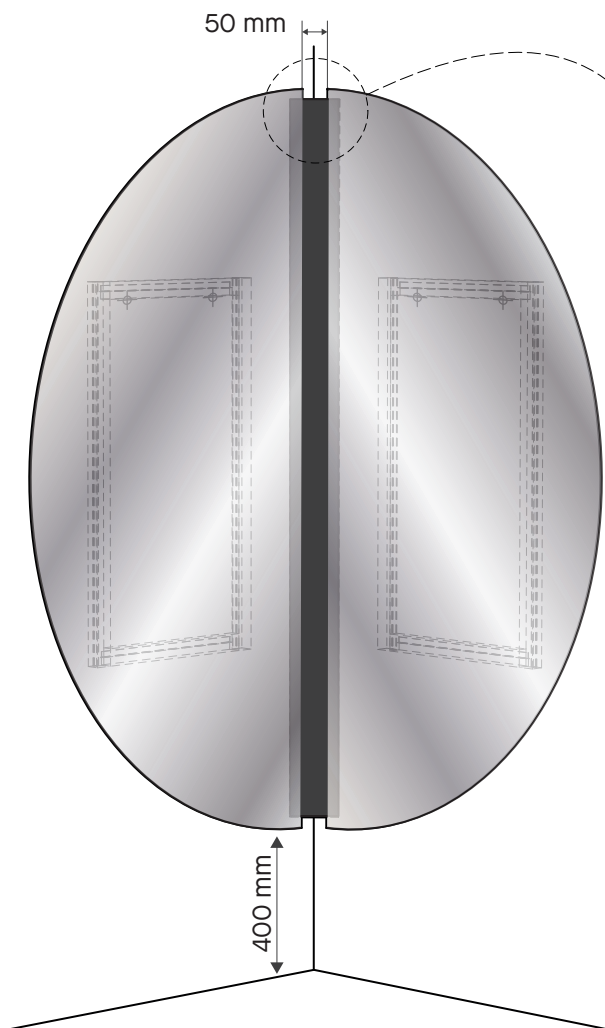

slide the mirrors in order to leave a 50mm gap and show the central element