

B.Light 4 Plus
 2802.495

suspension accessories delivered with the mirror

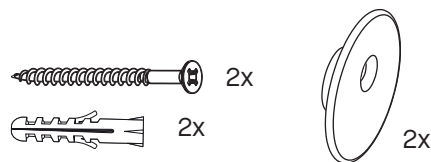
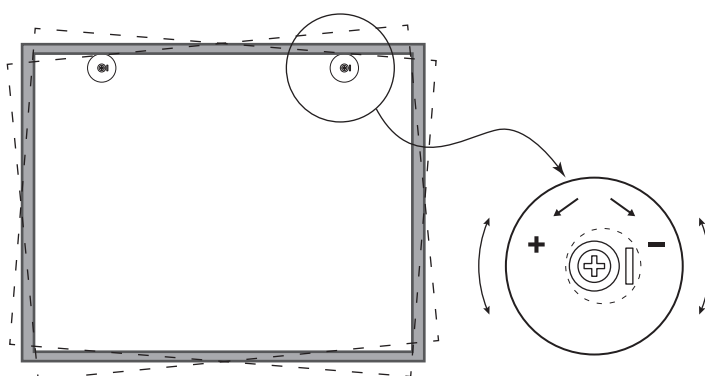
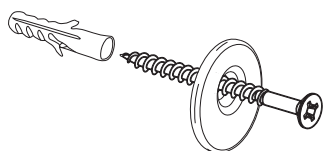

Mark the suspension point on your wall
 drill holes and place the plugs, washers
 and screws. The washers allow you to
 slightly adjust the level of the mirror.

CAUTION

Always turn off the power supply during
 installation and maintenance.

Hang the mirror at least 20cm above any object
 (washbasin, tap, cabinet, ...).

Hang the mirror parallel to the wall for optimal
 functioning of the sensor.

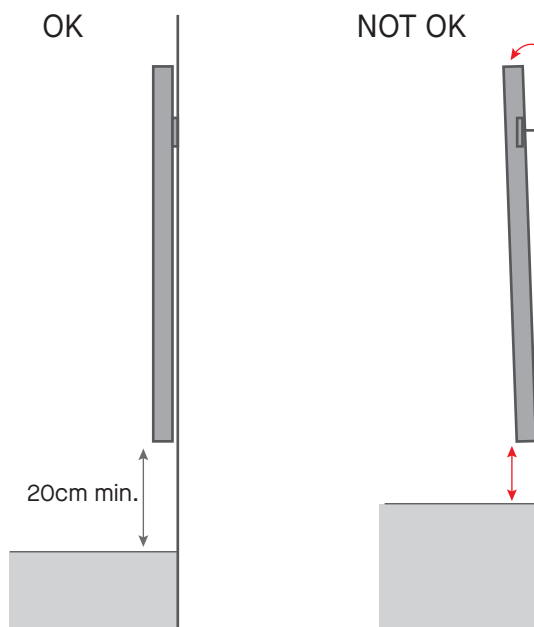

200-240 V
 Pmax: 60W
 Lamp type: flexible SMD 2835 LED, lifetime 30000h

